

AAHN 0050 F01 dt. 12.02.2014

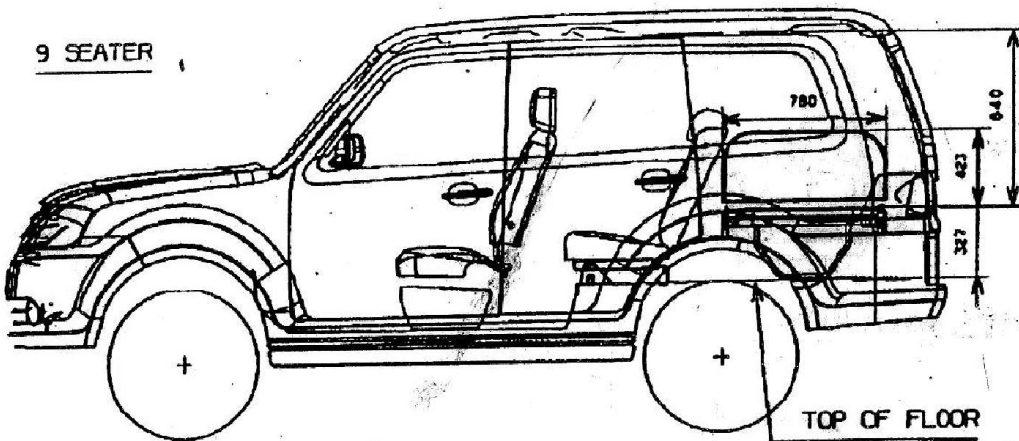

TATA SUMO GRANDE
SEATING LAYOUT 9 SEATER

9 SEATER



TOP OF FLOOR

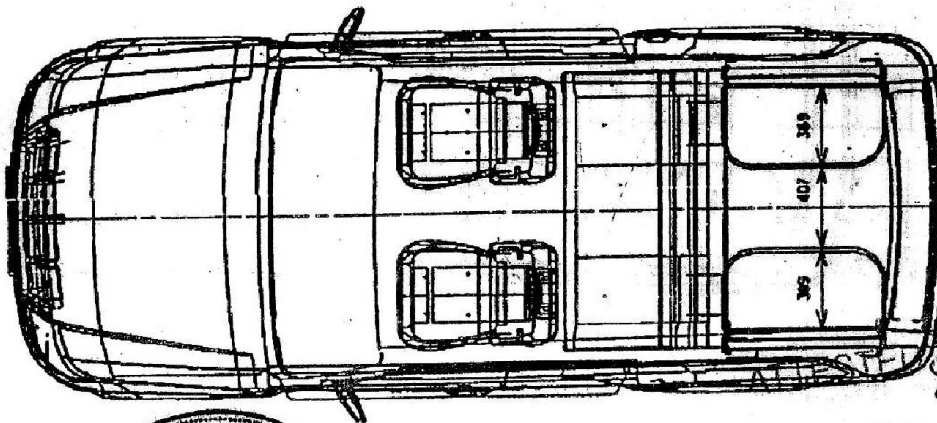

*Not fit for
All India
Permit*

*TRUE COPY
on 6.3.14*

S.K. THAKUR, Advocate & Notary
Dehradun (Uttarakhand) INDIA
Reg.No.-38 (01) 2004

DRIVER, CO-DRIVER SEAT & SECOND ROW SEAT
AS PER REGISTRATION NO 1 OF 2895 9970 00 14



P.K. BANERJEE
P.K. BANERJEE
Head (Homologation & PE)
ERC, TATA MOTORS LTD

ENGINEERING RESEARCH CENTER
TATA MOTORS LTD. PUNE 411 001

S.K. THAKUR, Advocate & Notary
Dehradun (Uttarakhand) INDIA
Reg.No.-38 (01) 2004

Document No

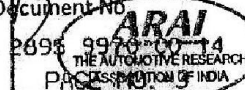

AAHN 0050 F01 dt. 12.02.2014



TATA SUMO GRANDE
SEATING LAYOUT 7 SEATER

7 SEATER

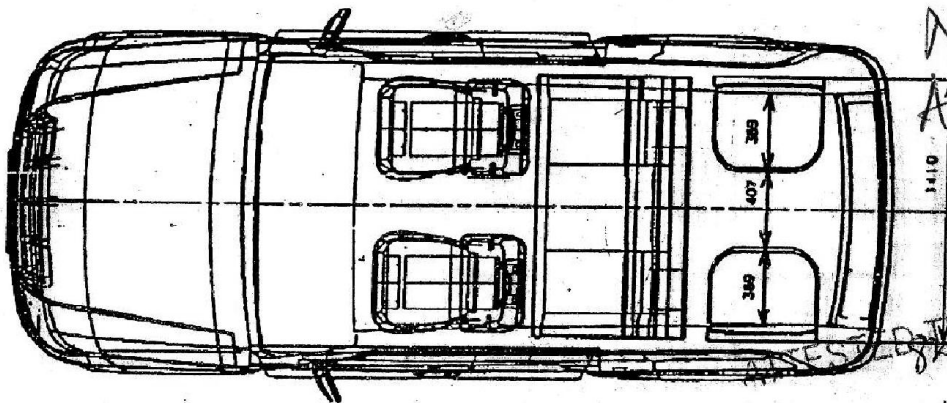
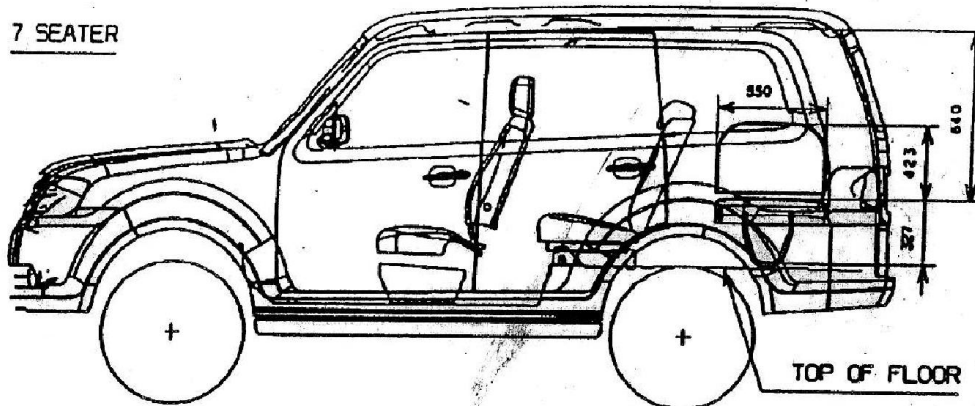

*Not fit for
Add India
Permit*

DIMNS. OF DRIVER, CO-DRIVER SEAT & SECOND ROW

ARE SAME AS SHIT NO 1 OF 2895-9970 00 14

S.K. THAKUR, Advocate & Notary,
Dehradun (Uttarakhand) INDIA
Reg.No.-38 (01) 2004

P.K. Banerjee
P.K. BANERJEE
Head (Homologation & PE)
ERC, TATA MOTORS LTD

OPTION 2-WITH SINGLE SEATER SIDE FACING JUMP SEAT



ATTESTED TRUE COPY

ENGINEERING RESEARCH CENTER
TATA MOTORS LTD. PUNE

Mrs. Rashmi Ordhwar
Deputy Director
HOMOLOGATION MANAGEMENT
REGULATION, ARAI PUNE

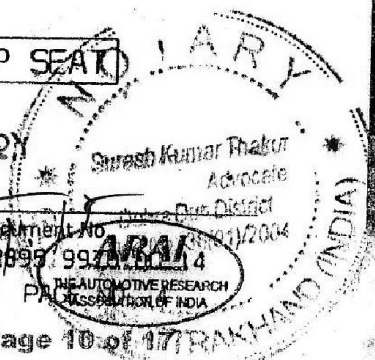

Registration No. AAH 4
2895-9970-00-14
THE AUTOMOTIVE RESEARCH
PUNJAB ASSOCIATION OF INDIA

AAHN 0050 F01 dt. 12.02.2014

TATA SUMO GRANDE

SEATING LAYOUT 7 SEATER



7 SEATER

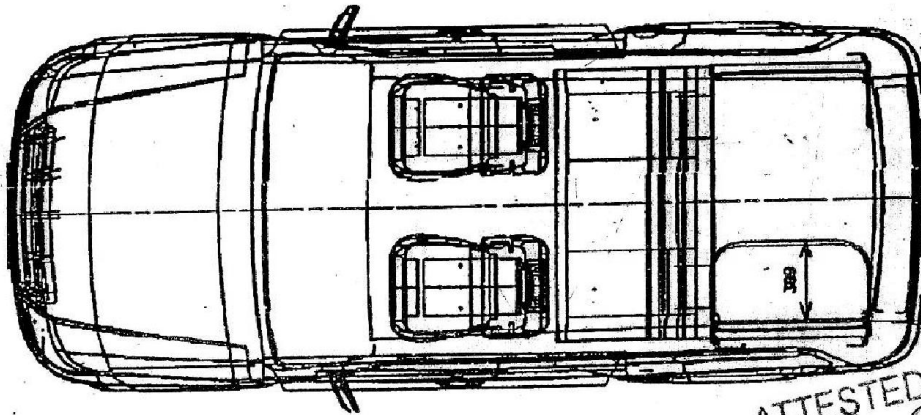
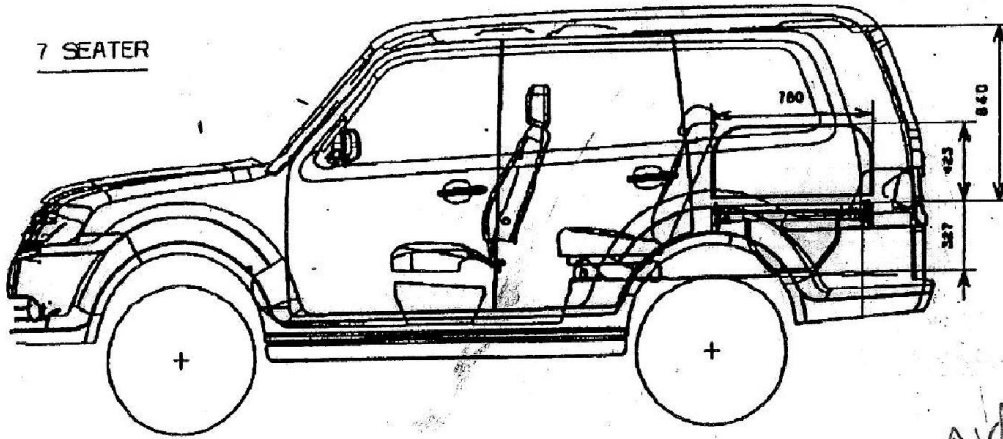

Not approved for sale in Uttarakhand. This version

Ramdas

ATTESTED TRUE COPY

S.K. THAKUR, Advocate & Notary
Uttarakhand (Uttarakhand) INDIA
Reg. No. 38 (01) 2004

P.K. Banerjee
P.K. BANERJEE
Head (Homologation & PE)
ERC, TATA MOTORS LTD



DIMS OF DRIVER, CO-DRIVER SEAT & SECOND ROW SEAT

AS SHOWN IN DRAWING NO 1 OF 2895 9970 00 14

OPTION 3 WITH TWO SEATER SIDE FACING JUMP SEAT LH

ATTESTED TRUE COPY



ENGINEERING RESEARCH CENTER
TATA MOTORS LTD, PUNE 411018
Deputy Director
HOMOLOGATION MANAGEMENT & REGULATION, ARAI PUNE

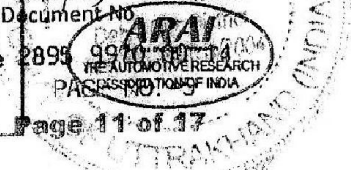

AAHN 0050 F01 dt. 12.02.2014



TATA SUMO GRANDE
SEATING LAYOUT 7 SEATER

7 SEATER

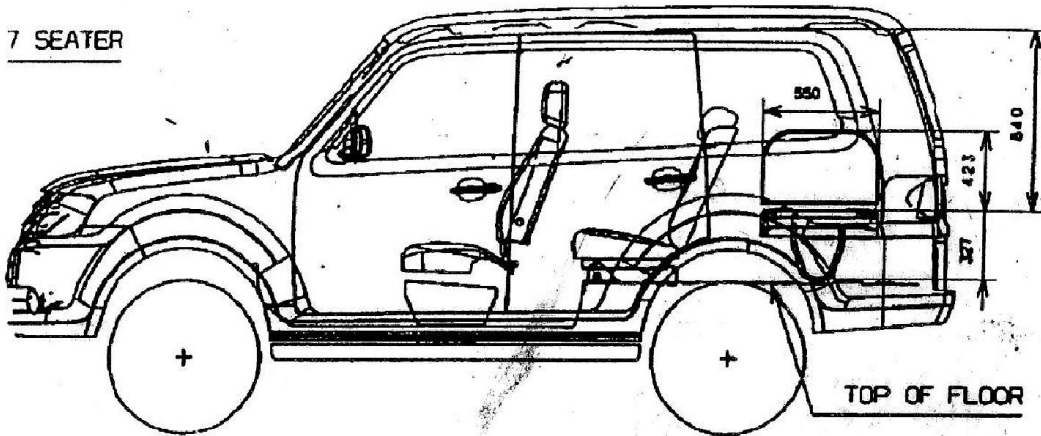

TOP OF FLOOR

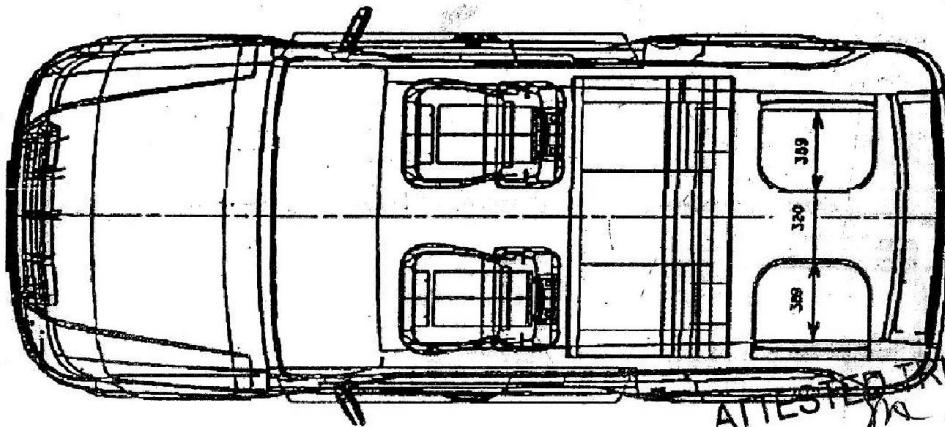

*Not fit for
All India
Permit*

ATTESTED TRUE COPY

S.K. THAKUR, Advocate & Notary
Dehradun (Uttarakhand) INDIA
Reg.No.-38 (01) 2004

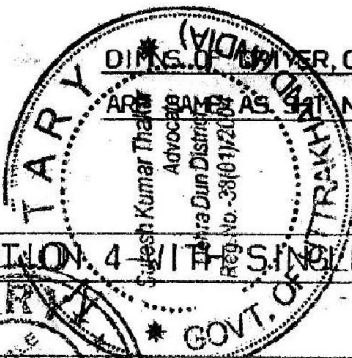

OPTION 4 WITH SINGLE SEATER CO-DRIVER SEAT & SECOND ROW SEAT
ARAI REG. NO. 1 OF 2895 9970 00 14

P.K. Banerjee
P.K. BANERJEE
Head (Homologation & PE)
ERC, TATA MOTORS LTD

OPTION 4 WITH SINGLE SEATER SIDE FACING JUMP SEAT

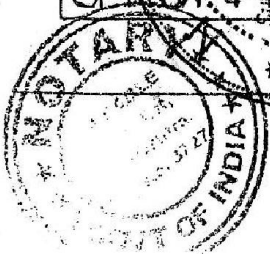

ENGINEERING RESEARCH CENTER
TATA MOTORS LTD. PUNE 411004

ATTESTED TRUE COPY
Mrs. Rashmi Urdhwarshi
S.K. THAKUR, Advocate & Notary
Dehradun (Uttarakhand) INDIA
Reg.No.-38 (01) 2004

Document No. 2895 9970 00 14
ARAI THE AUTOMOTIVE RESEARCH ASSOCIATION OF INDIA
Page 12 of 17



AAHN 0050 F01 dt. 12.02.2014



TATA SUMO GRANDE
SEATING LAYOUT 9 SEATER

Not fit for All India

9 SEATER

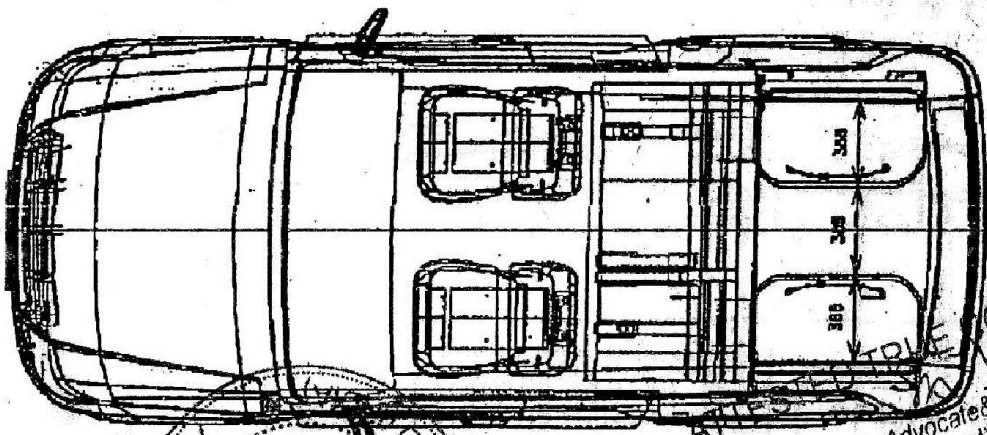
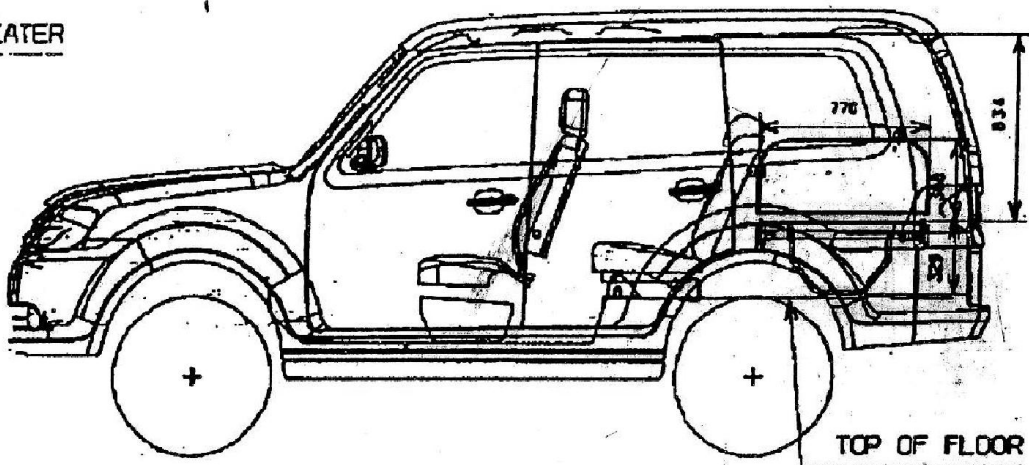

NOTARY
Suresh Kumar Thakur
Advocate
Dehra Dun District
Reg. No. - 38(01)/2004
GOVT. OF UTTARAKHAND

S.K. THAKUR, Advocate & Notary
Dehradun (Uttarakhand) INDIA
Reg. No. - 38 (01) 2004
P.K. BANERJEE
Head (Homologation & PE)
ERC, TATA MOTORS LTD

NOTARY
C. K. SAGLE
GOVT. OF INDIA

ENGINEERING RESEARCH CENTER
TATA MOTORS LTD. PUNE 4110
Mrs. Rashmi Urdhwares
Deputy Director
REGULATION MANAGEMENT
INDIA P.A. ASSOCIATION OF INDIA

Document No. 9999
THE AUTOMOTIVE RESEARCH
INDIA P.A. ASSOCIATION OF INDIA

STAMPED COPY
S.K. THAKUR, Advocate & Notary
Dehradun (Uttarakhand) INDIA
Reg. No. - 38 (01) 2004
Page 13 of 17
INDIA P.A. ASSOCIATION OF INDIA

AAHN 0050 F01 dt. 12.02.2014

TATA SUMO GRANDE

SEATING LAYOUT 7 SEATER



7 SEATER

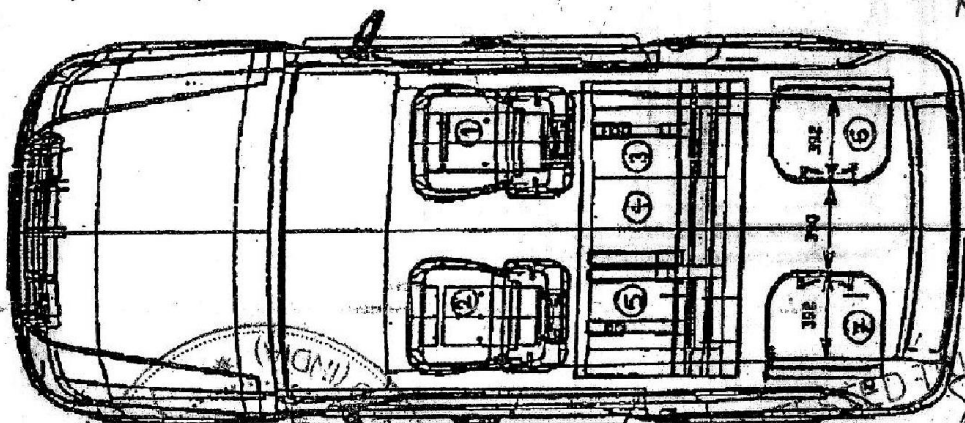
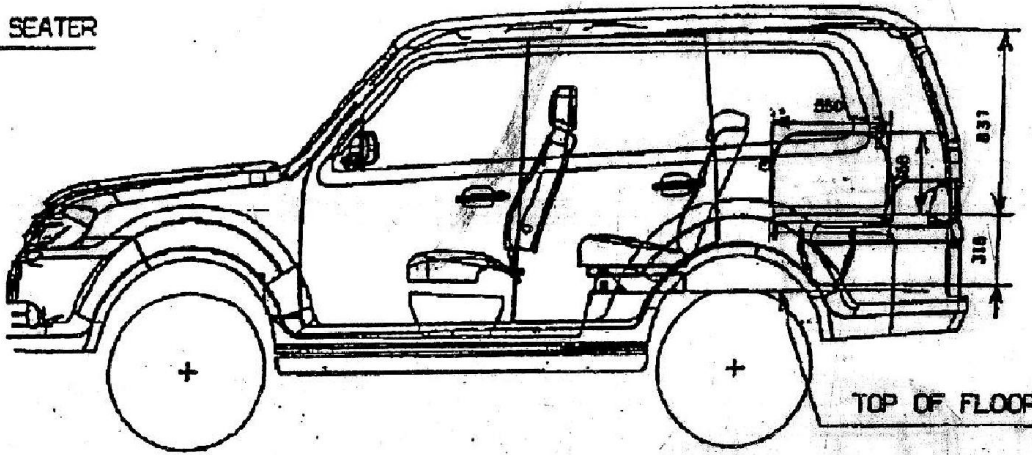

*Not fit for
All India
Permit*

*TRUE COPY
12/03/14*

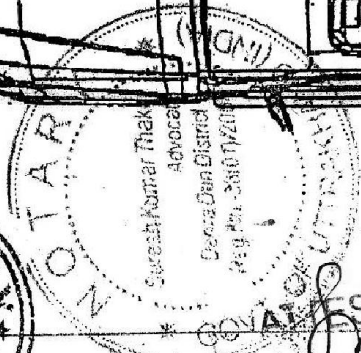

*S.K. THAKUR, Advocate & Notary
P.K. BANERJEE
Head (Homologation & PE)
ERC, TATA MOTORS LTD.*

ENGINEERING RESEARCH CENTRE
TATA MOTORS LTD. PUNE 411 008
Deputy Director
HOMOLOGATION MANAGEMENT



AAHN 0050 F01 dt. 12.02.2014



TATA SUMO GRANDE
SEATING LAYOUT 07 SEATER

07 SEATER

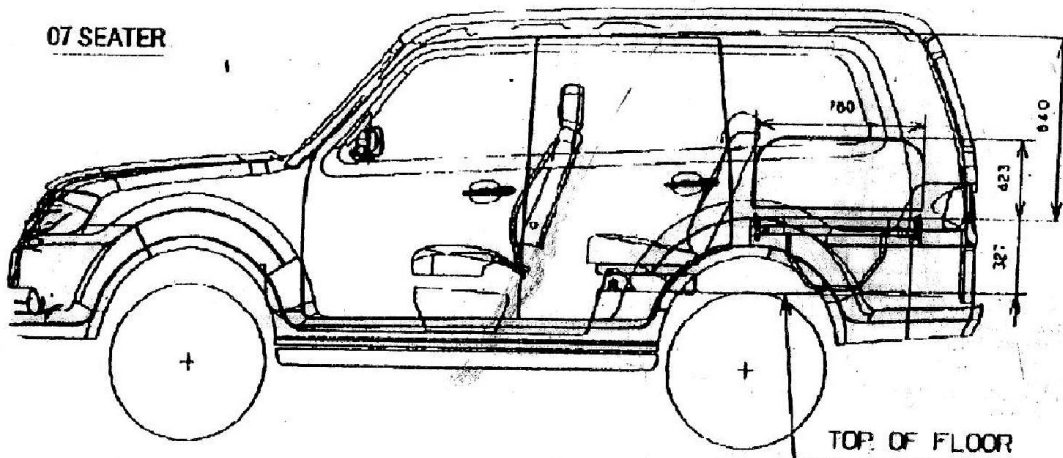

TOP OF FLOOR

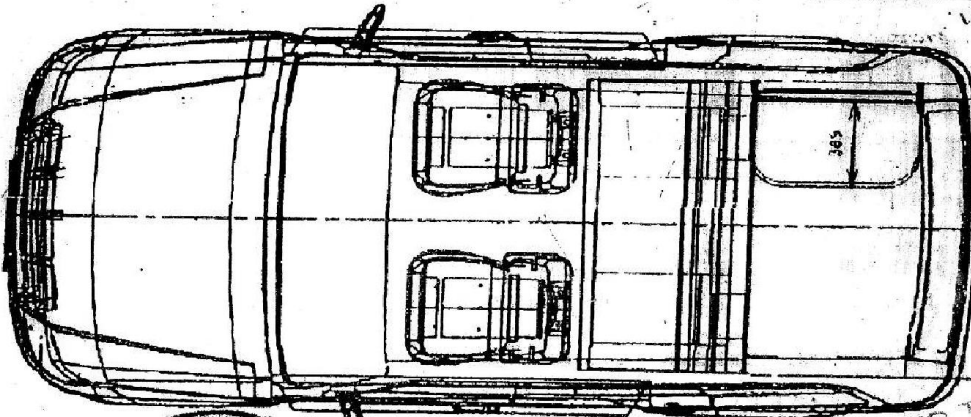

Tax Char!
Not appd for sale in UK

ATTESTED TRUE COPY
S.K. Thakur

DRIVER CO-DRIVER SEAT & SECOND ROW SEAT

ARISA SHEET NO 1 OF 2895 9970 00 14

S.K. THAKUR, Advocate
Dehradun (Uttarakhand) INDIA
Reg. No. 45 (A) 2004

P.K. BANERJEE
Head (Homologation & PE)
ERC, TATA MOTORS LTD

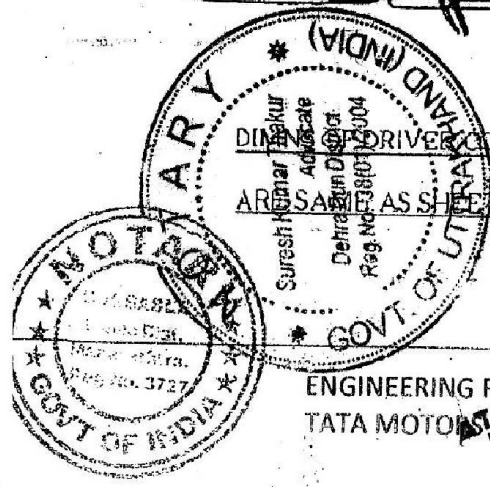

ENGINEERING RESEARCH CENTRE
TATA MOTORS LTD. PUNE

S.K. THAKUR
Dehradun
Reg. No. 45 (A) 2004

Mrs. Rashmi Urdhwareshe
Deputy Director
HOMOLOGATION MANAGEMENT & REGULATION, ARAI PUNE

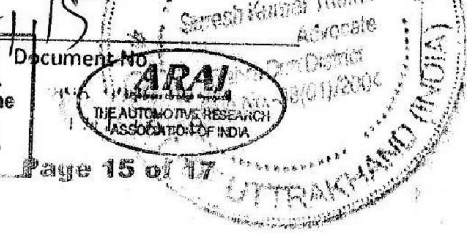

Document No. 115

AAHN 0050 F01 dt. 12.02.2014



TATA SUMO GRANDE
SEATING LAYOUT 7 SEATER

7 SEATER
WITH CAPTAIN SEAT

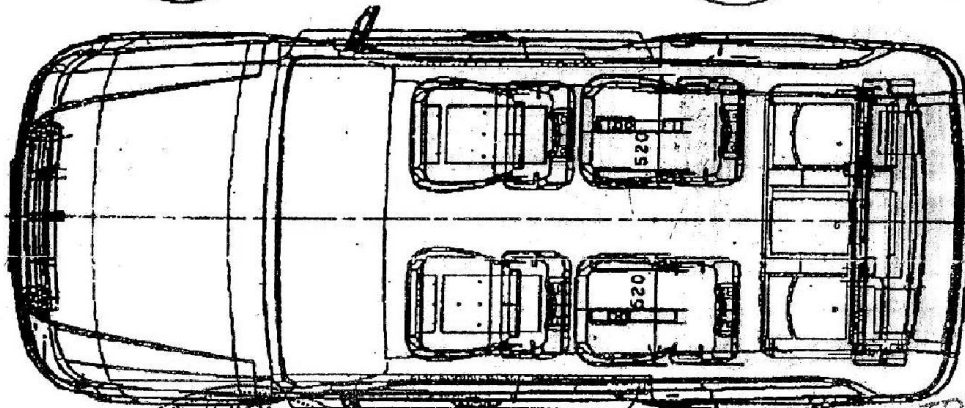
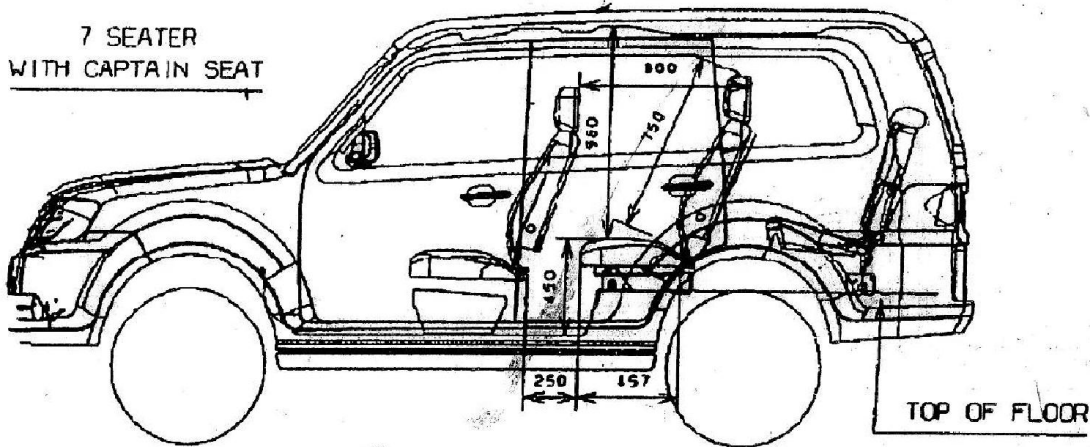

ok for All India

NOTARY
Kumar Thakur
Advocate
Dun District
Dun Distt
Reg. No. 38107/1983
UTTAR PRADESH (INDIA)

ATTESTED TRUE COPY

S.K. THAKUR, Advocate
Dehradun (Uttarakhand)
Reg. No. 38107/1983

DIMNS OF DRIVER, CO-DRIVER SEAT & THIRD ROW SEAT
ARE SAME AS SHT. NO. 1 OF 2895 9970 00 14 (8 SEATER)

NOTARY
P.K. BANERJEE
Dun District
Dun Distt
Reg. No. 38107/1983

P.K. BANERJEE
Head (Homologation & PE)
ERC, TATA MOTORS LTD

ATTESTED TRUE COPY
ENGINEERING RESEARCH CENTRE
TATA MOTORS LTD, PUNE
S.K. THAKUR, Deputy Director
Dehradun
HOMOLOGATION MANAGEMENT
REGULATION, ARAI PUNE

Document No. 115
99
THE AUTOMOTIVE RESEARCH
ASSOCIATION OF INDIA

AAHN 0050 F01 dt. 12.02.2014



TATA SUMO GRANDE
SEATING LAYOUT 5 SEATER

5 SEATER

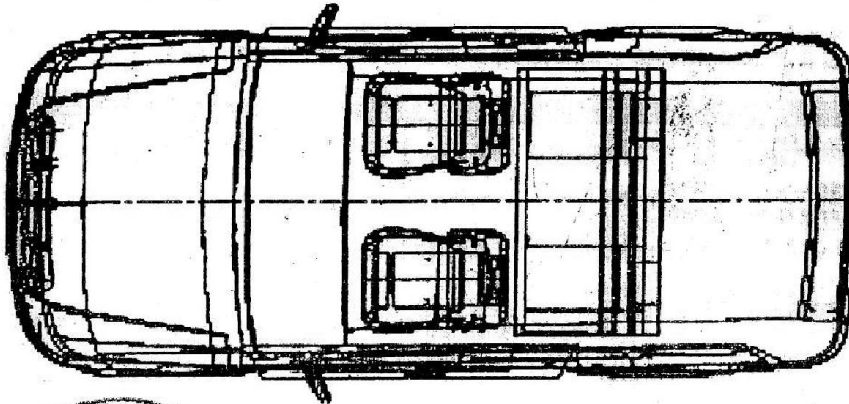
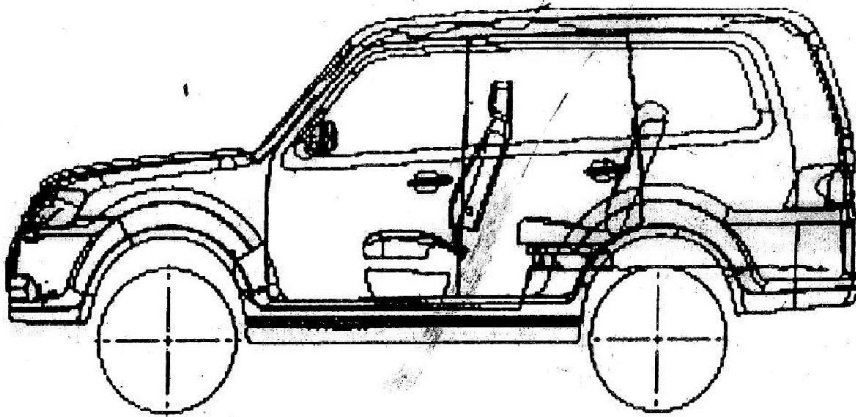

2. Tax Chori
Not appd for
sale

26/2/2014

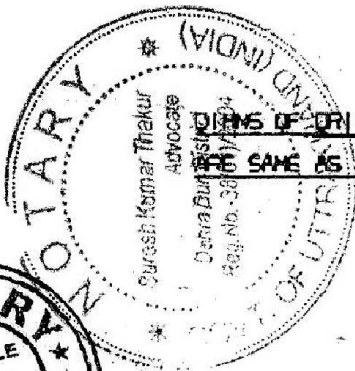

DIAGRAM OF DRIVER, CO-DRIVER SEAT & SECOND ROW SEAT
IS SAME AS SHIT NO 1 OF 2895 9970 GD 14

ATTESTED TRUE COPY



ATTESTED TRUE COPY



ENGINEERING RESEARCH CENTER
TATA MOTORS LTD PUNE

Mrs. Rashmi Urdhwarshi
Deputy Director
REGULATION MANAGEMENT & REGULATION, ARAI PUNE

Document No. 2895 9970 GD 14
Page No. 11/2004